

DETAIL AT F

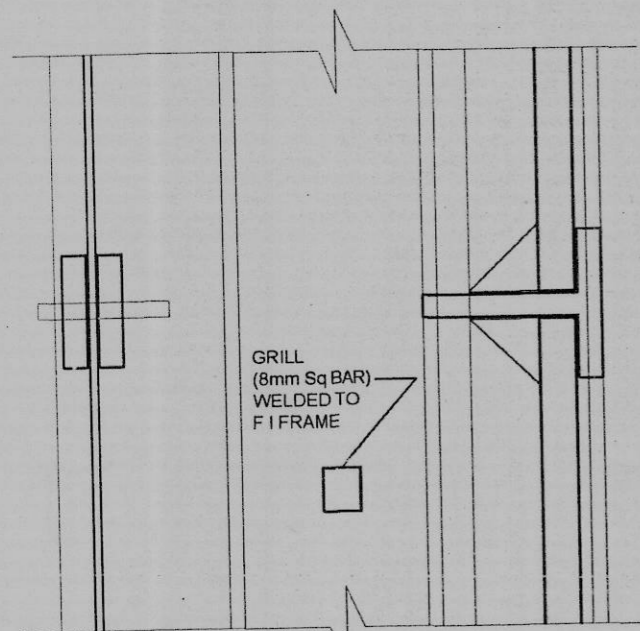

DETAIL AT G

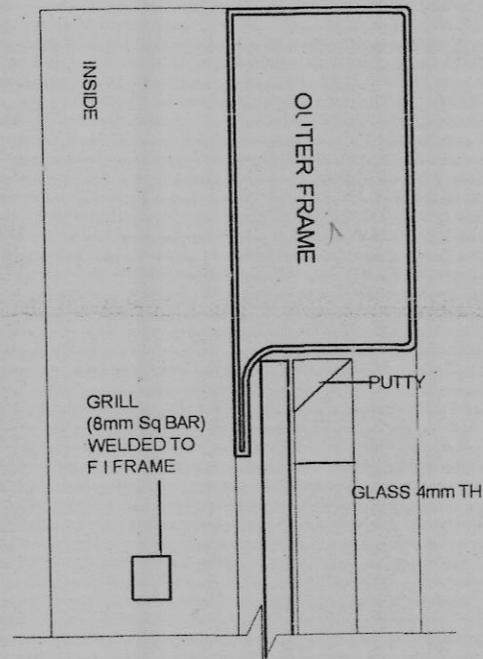

DETAIL AT E

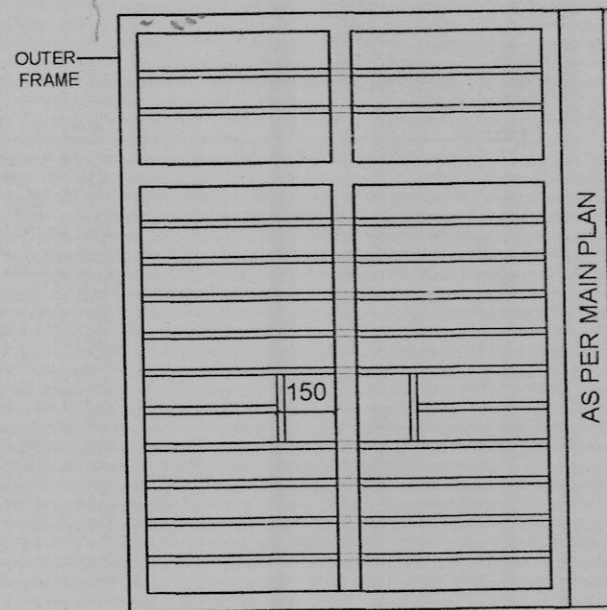

AS PER MAIN PLAN
ELEVATION OF GRILL

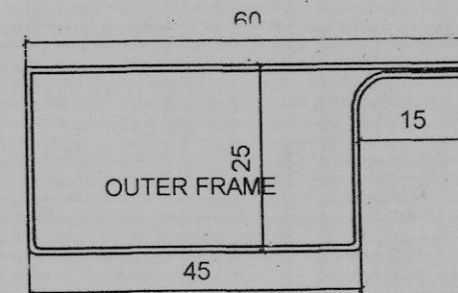

DETAIL OF OUTER SHUTTER FRAME MADE OF ERW TUBE 'P' SECTION

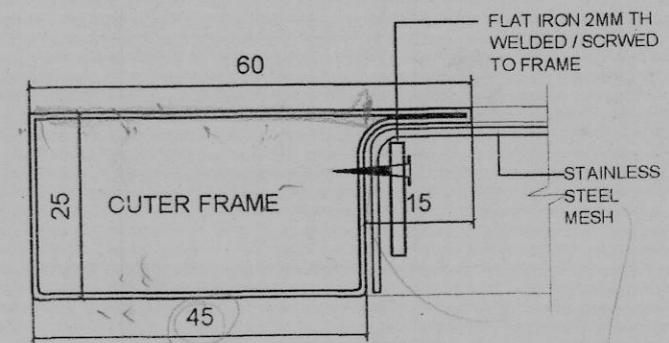
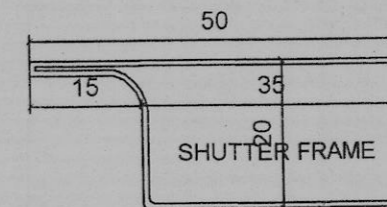
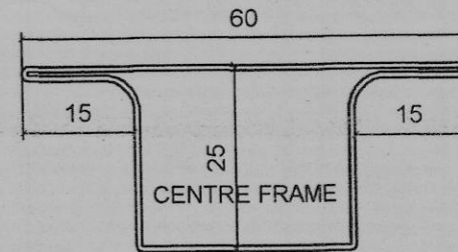

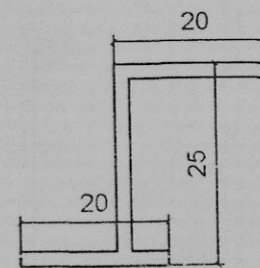

FIXING DETAIL OF WIREMESH WITH SHUTTER FRAME

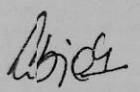

DETAIL OF 'Z' SECTION AS HANDLE AND STOPPER

S NO	DATE	DESCRIPTION	INITIAL
REVISION			
TYPICAL DETAIL OF BOX WINDOW (STEEL WITH FLY PROOF SHUTTER)			
DATE	21-05-06		
DRN		CHIEF ENGINEER	3/3
TCD		JALANDHAR ZONE	
CHD			
SCALE	AS SHOWN	DRG. NO CEJZ/TD-1020/06	



 CHIEF ENGINEER
 JALANDHAR ZONE
 ADD. JALANDHAR